

# Programmable High Power AC & DC Electronic Load

**GPIB**



# Descriptions:

The 3256 and 3700 series programmable high power electronic load is designed for engineering evaluation and production testing of high power source such as UPS, inverters, batteries, and generators for a volt to 300 volts, 0 to 36 amps, and up to 3.6KW. High reliability is achieved by using Master/Slave paralleling configuration and Active Power Dissipation Balance technology where each load unit sink same amount of power. The state-of-the-art Master/Slave paralleling configuration features your static and Pulse Current loading applications, GPIB and manual programming, CC/CR/CF loading modes, engineered for high performance with reasonable budget. For the Master and Slave load unit is a stand alone unit, the advantage of Master/Slave configuration includes quick delivery schedule, easy configuration, shipping delivery, installation, and cost effective, etc. The dynamic pulse current loading includes wide range variable rates crest factor, STEP and SQUARE waveform controls. This features enable to simulate the real world loading activities. Custom or modification are available and it should be specify V/A/W ratings; please contact Prodigit sale office or distributor for more detailed information.

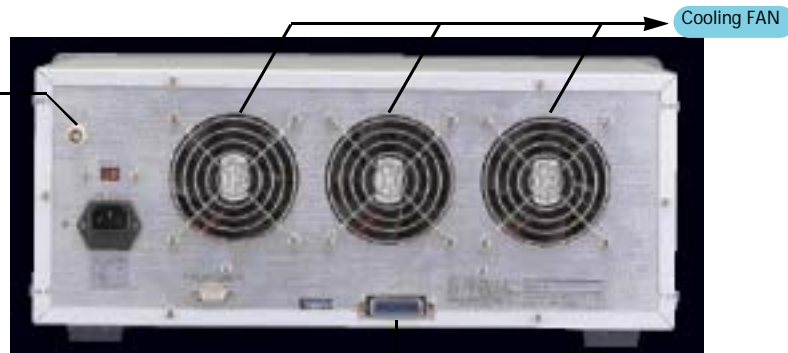
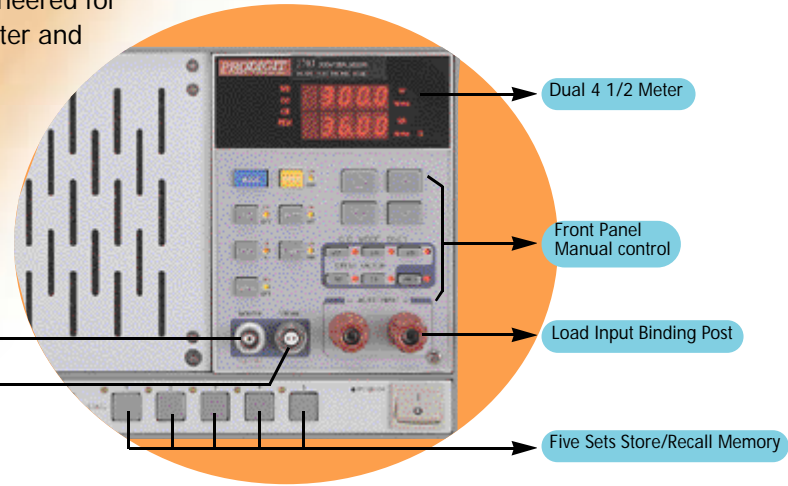

# Key Features:

- Master/Slave paralleling configuration
- Active Power dissipation balance technique
- Local and GPIB Programming
- Up to 3.5 Crest Factor Current Loading
- Protections against V, I, W, and °C
- Up to 70HZ Power Frequency
- Auto-Frequency Capability to sync with AC Source input (Option)
- GPIB Setting/Read back capability

- CC, CR, CF, mode
- Voltage up 300V, current up to 36A, power up to 3600w
- 5 sets Store/Recall memory
- Dual 4 1/2 V/A Meter
- Custom/Modification available
- Isolated Current Monitor output

## CR Operation Mode Application

Voltage Source or current Source Testing

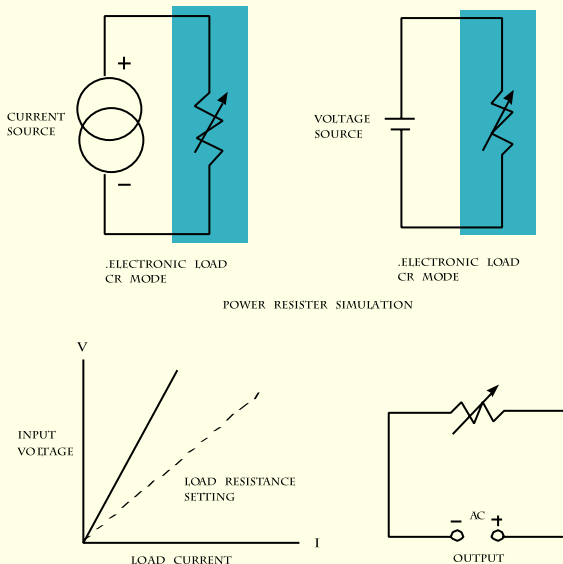

## CC Operation Mode Application

CC Operation mode is very suitable for load regulation, cross regulation and output voltage adjust tests of the power supplier and for battery discharge testing and service life eyele testing. Voltage source Testing

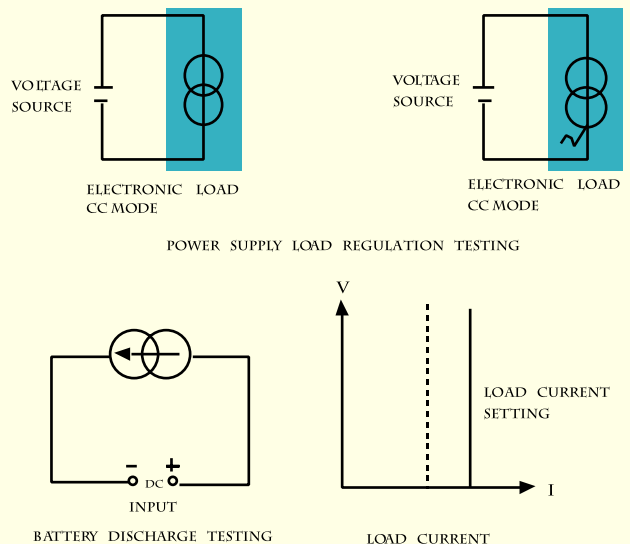

# Master and Slave system connection for 3500 Series

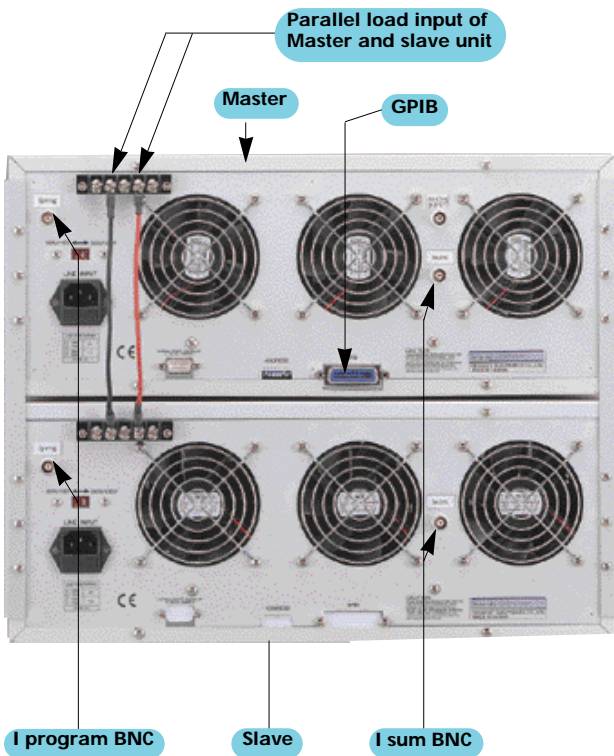

## 1. System rack:

- The industrial standard 19" wide system rack can be used for the high power electronic load, a recommend dimension is in figure.
- The 3703 uses 8 U high rack kit to integrate Mater and slave unite together.

## 2. Installation into rack:

- Allocate 4U high (177mm) for each load unit in the system rack, no space is required for inter-load unit, for the direction of cooling flow is from front to back panel of the system.
- Figure shows how to mount master load unit the system rack with screws on the right and left hand side of load unit, please do the same way to mount slave unite.

## 3. AC Power cord connection and AC power switch:

- The high power load system needs an AC power switch control all load units ON or OFF .
- The system AC power switch is located on the master load unit.

## 4. Load input Bus Bar parallel:

- The load input terminal (+ and - ) on the rear panel should be paralleled together, please refer figure to mount load unit in parallel connection, this layout can provide necessary room for the AC power cord.
- The system Positive and Negative load input (+ and - ) can be wired from front panel's Load input connector.

## 5. I - program and I - sum parallel connection:

- The I - program and I - sum are the analog control bus for the high power load system.
- I - program signal is used to control the load current of slave unit, it provides equal current sharing for all load units.  
The I - program BNC output of Master load unit connects to the I - program BNC input of each Slave load unit by BNC - BNC cable in parallel.
- The I - sum signal is used to add the load current of load unit, this enable the current meter in master unit can display total system load current.  
The I - sum BNC input of Master load unit connects to the I - sum BNC output of Slave load unit by BNC - BNC cable in parallel.

## Crest Factor loading:

- Built-in  $\sqrt{2}$  to 3.5 Current Crest Factor Waveforms to Simulate Real World Current Waveforms

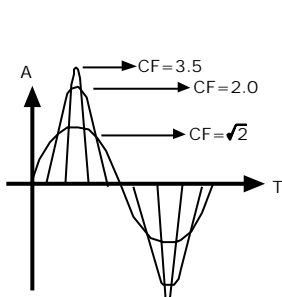

Crest Factor =  $\sqrt{2}$ -3.5  
Current Waveform of Sine-wave  
(Memory 1-25)

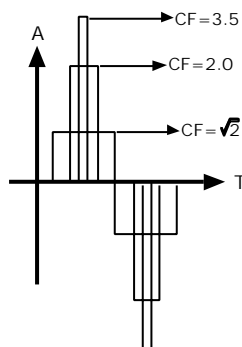

Crest Factor =  $\sqrt{2}$ -3.5  
Current Waveform of Pulse-wave

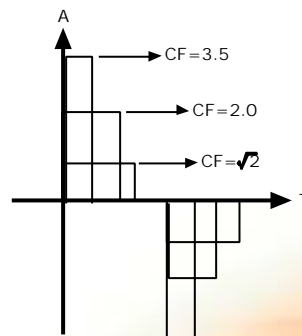

Crest Factor =  $\sqrt{2}$ -3.5  
Current Waveform of Square-wave

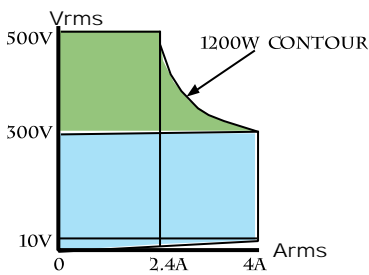

**3254 POWER CONTOUR**

DC:0~500 Vdc  
AC:0~300 Vrms

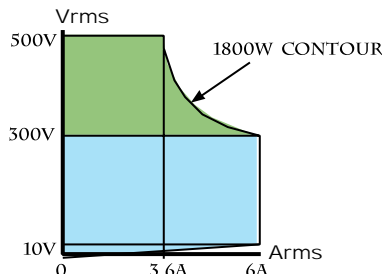

**3255 POWER CONTOUR**

DC:0~500 Vdc  
AC:0~300 Vrms

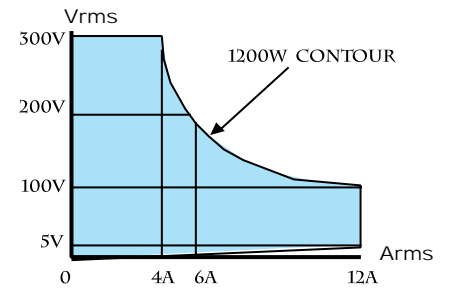

**3256 POWER CONTOUR**

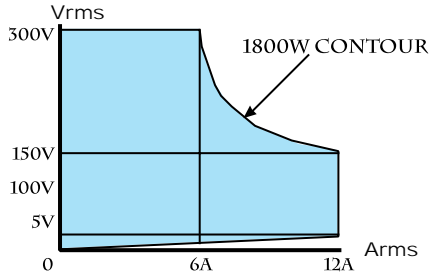

**3256E POWER CONTOUR**

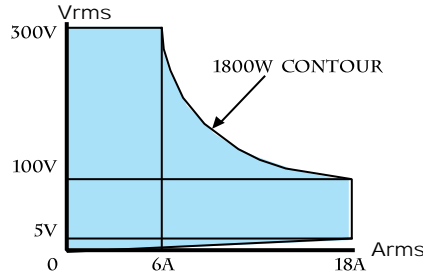

**3257 POWER CONTOUR**

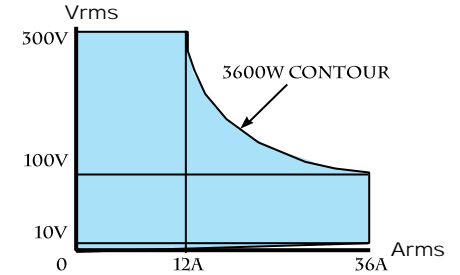

**3703 POWER CONTOUR**

MODE	3254	3255	3256/3256E	3257	3703
<b>INPUT RATINGS</b>					
Power(Watt)	1200W	1800W	1200W/1800W	1800W	3600W
Current(Ampere)	4Arms	6Arms	12Arms	18Arms	36Arms 54Apeak
Voltage(Volt)	300Vrms/500Vdc	300Vrms/500Vdc	300Vrms	300Vrms	300Vrms
<b>CC MODE Freq:</b>					
DC, 40-70Hz	0~2/2	0~3/3	0~6/6~12Arms	0~9/9~18Arms	0~18/36Arms
Resolution	0.5/1mA	0.75/1.5mA	1.5/3mA	2.25/4.5mA	4.5/9.0mA
Crest Factor:	√2, 1.5~3.5:STEP 0.1				
<b>CR MODE Freq:</b>					
DC, 40-70Hz	12.5~50 ~200KΩ	8.333~33.33 ~133KΩ	5~20~80KΩ ~53.33KΩ	3.333~13.33 ~26.666KΩ	1.666~6.666 ~26.666KΩ
Resolution	0.005/0.02mS	0.0075/0.03mS	0.013/0.05mS	0.019/0.075mS	0.15/0.0375mS
4 1/2DVM	500V	500V	0.0~300.0V		300V
	Accuracy				±0.5% of (reading+range)
	Resolution				0.1V
4 1/2DAM	4A	6A	12A	18A	36A
	Accuracy				0.01A
	Resolutin				0.000~12.000A
±0.5% of (reading+range)					
WATT METER	0.0~1200.0W	0.0~1800.0W	0.0~1200.0W	0.0~1800.0W	3600W
VA METER	0.0~1200.0VA	0.0~1800.0VA	0.0~1200.0VA	0.0~1800.0VA	VrmsxArms Correspond to Vrmsand Arms
Accuracy	0.05% of(reading+range)				±0.5% of(reading+range)
Operation Temp	0~40°C De-rate to 77% @ 40°C				
I-monitor(Isolated)	1A/V	1.5A/V	3A/V	4.5A/V	9A/V
Dimension WXHXD(unit)	483X177X445		483X177X455		483X356X477

ms=milli-sienmen= 1/KΩ

**General:**

- AC Power : 115/230V(10%, 50/60Hz)
- Cooling : Force Fan Cooled
- GPIB : Listen/Talk

**Accessories:**

- AC Power Cord 1 pc
- BNC-Clip Cable 1 pc
- BNC-BNC Cable 1 pc
- Operation Manual 1 pc

**Options:**

- 1M GPIB Cable
- 2M GPIB Cable
- Cabinet



**Prodigit Electronics**

4F., No. 10, Alley 59, Lane 42, Min-chuan Rd.,  
Hsin-tien, Taipei, Taiwan, R.O.C.

TEL: +886-2-29182620

FAX: +886-2-29129870

Data Subject to Change without Notice

